



Camera and Electronic Products for Integrators

# Quick-Connect™ 4

## Video, Power and Control Wiring Center

**Figure 1:**  
Vaddio Quick-Connect 4  
Video, Power and Control  
Wiring Center

Front Panel (above) and  
Back Panel (below) shown



### INTRODUCTION

The Vaddio™ Quick-Connect 4, Video, Power and Control Wiring Center (Figure 1) simplifies Operator and Presenter camera systems using the Vaddio EZCamera™ Cabling standard. The Quick-Connect 4 can accommodate up to four separate Vaddio PTZ cameras, combining and consolidating four Vaddio Quick-Connect Boxes, four PowerRite™ power supplies and four EZCamera Control Adapters used with the EZCamera cable system.

Each camera port has an individual 18VDC supply to power a single PTZ camera. Power is provided to the camera and S-Video and Composite video are both returned to the Quick-Connect 4 on the same single Cat. 5 cable for Power/Video.

Individual control ports are supplied for camera control systems like the ProductionVIEW™ and camera control daisy chaining is accommodated through the first camera control port as well.

Control inputs are either DB-9 or RJ-45 and control outputs are RJ-45, which connect easily with all Vaddio WallVIEW™, CeilingVIEW™, EZCamera and HideAway series cameras.

### INTENDED USE

Before operating the Vaddio Quick-Connect 4, please read the entire manual thoroughly. The wiring system was designed, built and tested for use indoors. Outdoor operation is not recommended, has not been tested and could damage the unit and/or create a potentially unsafe operating condition. Use only the Vaddio provided power supply.

### SAVE THESE INSTRUCTIONS

The information contained in this manual will help you install and operate your Vaddio Quick-Connect 4. For reference, Vaddio keeps copies of Specifications, Installation and User Guides and most pertinent product drawings for the Vaddio product line on the website. These documents can be downloaded from [www.vaddio.com](http://www.vaddio.com) free of charge.

### IMPORTANT SAFEGUARDS

Read and understand all instructions before using. Do not operate the device if it has been dropped or damaged. In this case, a Vaddio technician must examine the product before operating. To reduce the risk of electric shock, do not immerse in water or other liquids and avoid extremely humid conditions.



**Use only the power supply provided with the Quick-Connect 4 Wiring Center. Use of any unauthorized power supplies will void any and all warranties.**

**UNPACKING**

Carefully remove the device and all of the parts from the packaging.  
*Unpack and identify the following parts:*

- One (1) Quick-Connect 4 Wiring Center (rack mount)
- One (1) 18VDC, 5.5Amp, 100W PowerRite Power Supply
- Installation and User Guide (341-256-1)

**INSTALLATION**

The Quick-Connect 4 was specifically designed for simplifying the installation of camera systems using the Vaddio Cat. 5 cabling scheme for distribution of Video (*both S-Video and Composite video*) and Power on the same Cat. 5 cable with Control handled on a second Cat. 5 cable which adheres to both the Sony and Canon Daisy chain wiring convention for control of multiple cameras with a single control port. Below is a list of compatible Vaddio Camera Systems using the Vaddio wiring standard.

**Compatible Camera Systems**

**The Quick-Connect 4 is compatible with the following Vaddio cameras and Camera Systems:**

- Vaddio WallVIEW 100
- Vaddio WallVIEW 70
- Vaddio WallVIEW 50i
- Vaddio CeilingVIEW 70 PTZ
- Vaddio CeilingVIEW 70 PTZ HideAway\*
- Vaddio CeilingVIEW 50iR PTZ
- Vaddio WallVIEW 50i PTZ HideAway\*
- EZCamera PTZ Series Camera Kit (Camera, Cat. 5 Shoe and Remote)
  - Vaddio Model 100 PTZ
  - Vaddio Model 70 PTZ
  - Vaddio Model 50 PTZ
  - Vaddio Model 50iR PTZ

*\*Note: Due to the power requirements for proper operation, the Quick-Connect 4 can supply power to only two (2) of the HideAway products (CeilingVIEW 70 PTZ HideAway and WallVIEW 50i PTZ HideAway) at any given time.*

**Controls, Inputs and Outputs (Camera 1)**

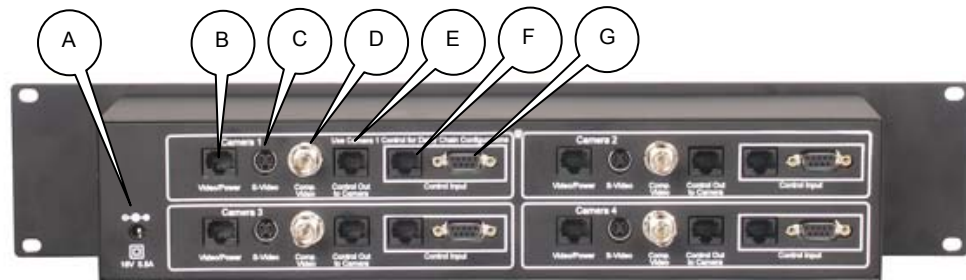
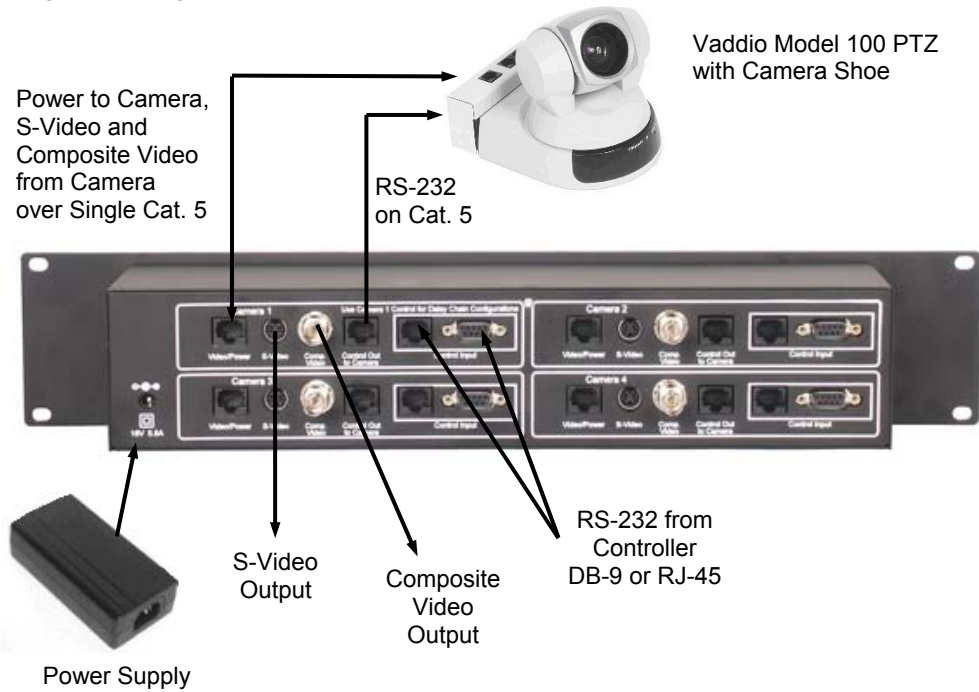

**Figure 2: Back Panel Connections**

- A) Power Input (18V, +center, 5.5A) Supports up to Four (4) PTZ Cameras
- B) Video/Power Connection – Carries Power to the camera and returns S-Video and Composite Video to the Quick-Connect 4
- C) S-Video Output of Camera on 4-pin mini din
- D) Composite Video Output of Camera on BNC
- E) Control Through Output Port to Camera (RS-232 on Cat. 5 cable)
- F) Control Through Input Port from Controller (RS-232 on Cat. 5)
- G) Control Through Input Port from Controller (RS-232 on DB-9)

**BASIC CAMERA CONNECTION**

**Figure 3: Single Camera Connection**



**4-Camera Daisy Chain Control Example (1-Control Port)**

**ControlVIEW Xtreme & Quick-Connect 4**

**Figure 4: Daisy Chain Example with Single Control Port**

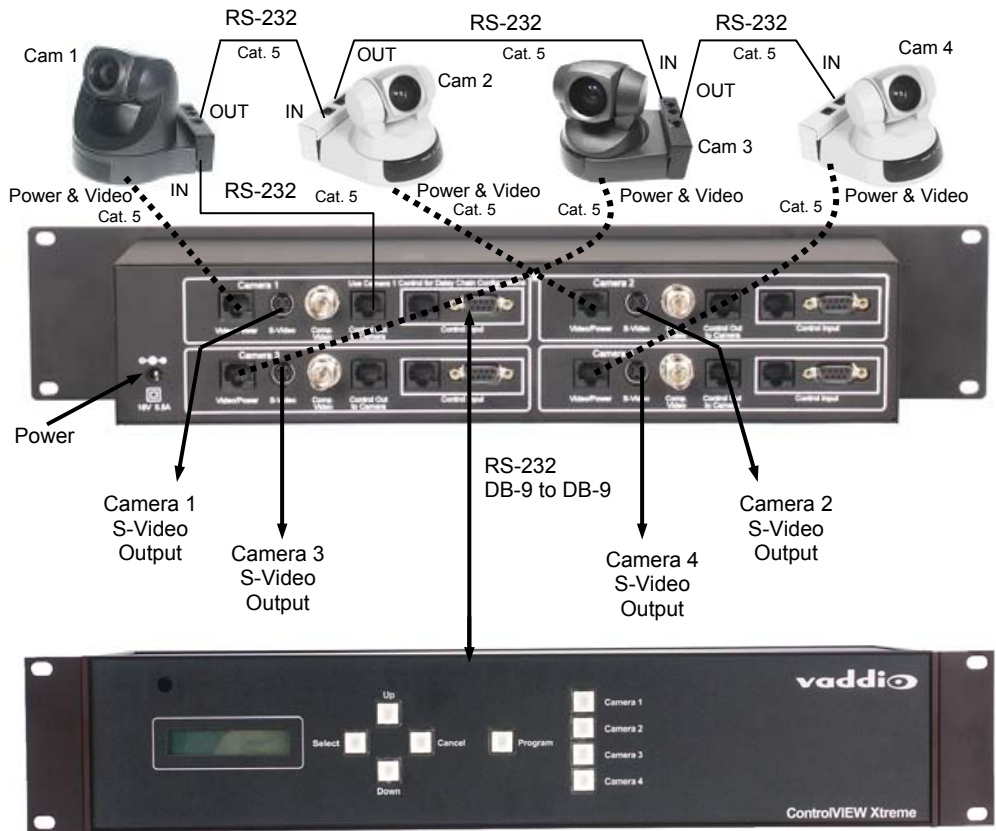

**Vaddio ControlVIEW Xtreme**

**4-Camera  
Direct Control  
Example  
(4-Control Ports)**

**ProductionVIEW  
&  
Quick-Connect 4**

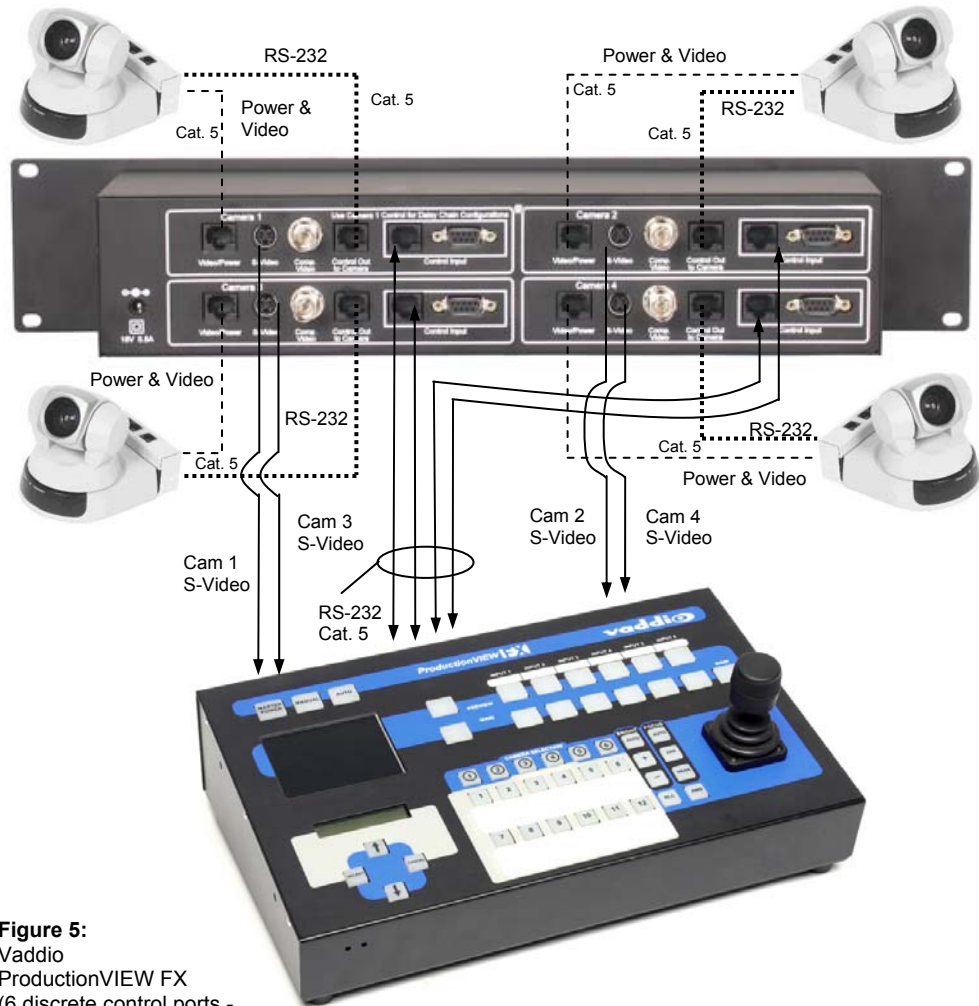

**Figure 5:**  
Vaddio  
ProductionVIEW FX  
(6 discrete control ports -  
no daisy chain control)

**4-Camera  
Quick-Connect 4  
Head End Daisy  
Chain Example  
(1-Control Port)**

**Note: Cat. 5 Cable  
Maximum Length for  
this Control  
Configuration:  
50'/15.24m**

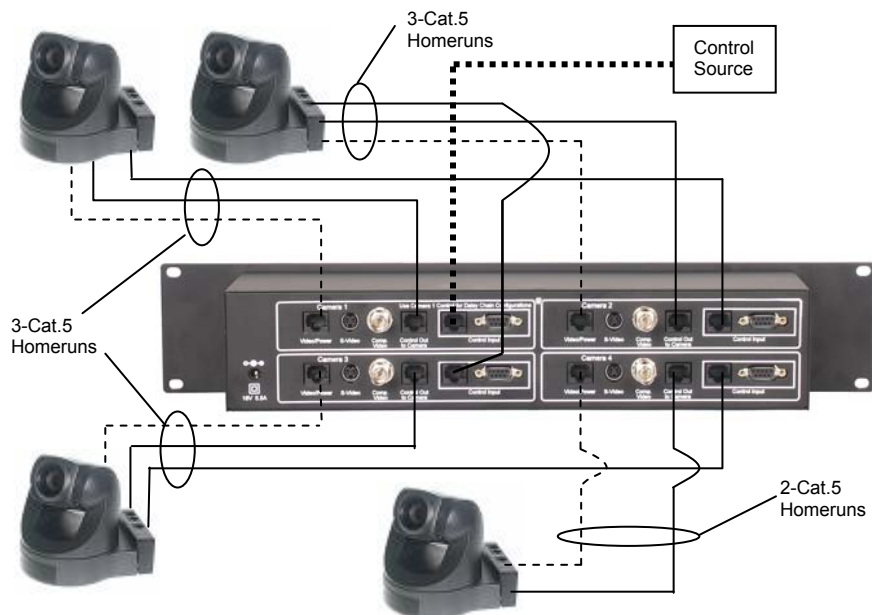
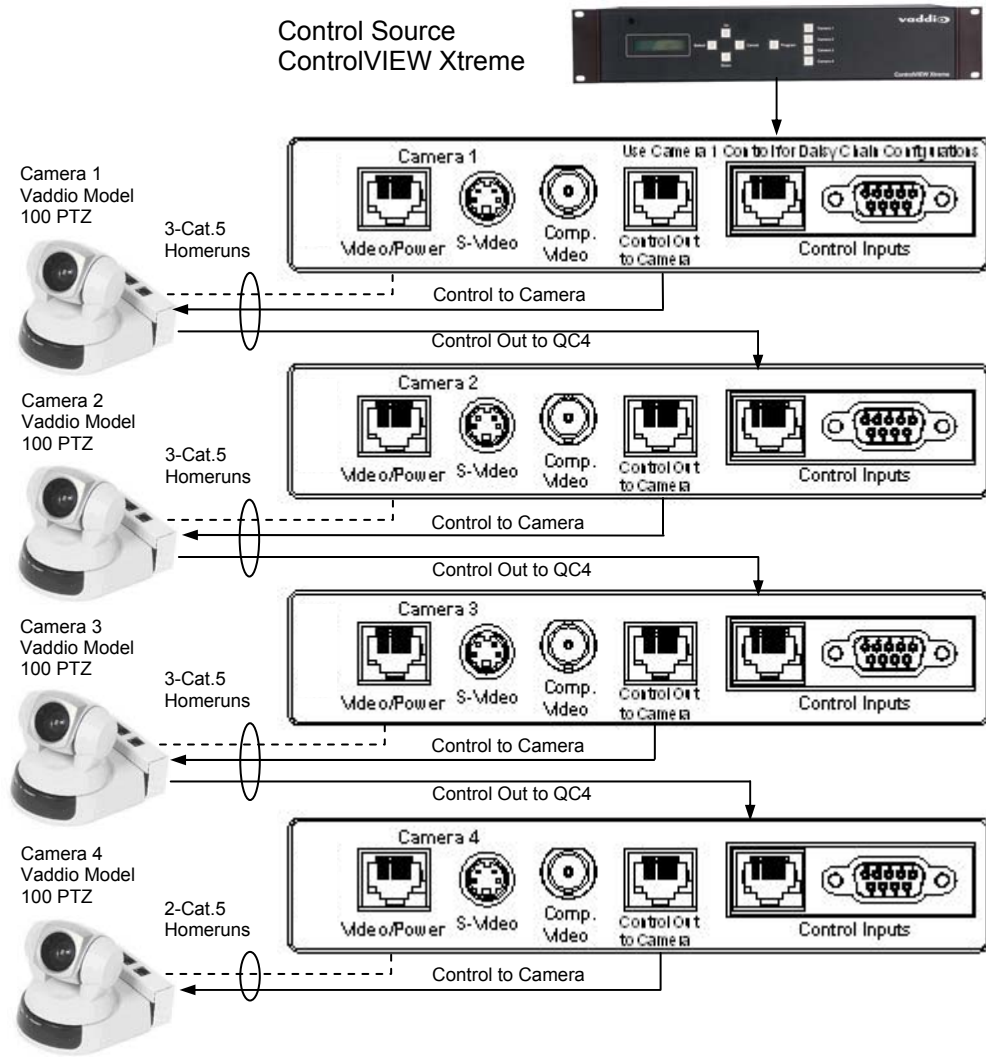

**Figure 6:** Head End Daisy Chain Example (see Figure 7 for I/O detail)

**4-Camera Quick-Connect 4 Head End Daisy Chain Example Detail**

**Note: Cat. 5 Cable Maximum Length for this Control Configuration: 50'/15.24m**

**Figure 7:** Connection Detail for Head End Daisy Chain using the Quick-Connect 4



**PIN-OUTS**

The pin-outs for the Quick-Connect 4's Video, Power and Control connectors are as follows:

**Video/Power**

**Video/Power Connection RJ-45**  
**RJ-45 Pins**

- 1) Power (+)
- 2) Power GND
- 3) Video GND
- 4) Y (luminance)
- 5) Video GND
- 6) C (Chrominance)
- 7) Video GND
- 8) Composite Video

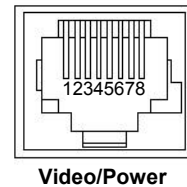

**Control Inputs**

**Control Input Connections  
RJ-45 and DB-9F**

RJ-45 Pins

- 1) DTR (Sony\* Daisy chain to DSR)
- 2) DSR (Sony\* Daisy chain from DTR)
- 3) CTS (Canon Daisy chain to RTS)
- 4) RTS (Canon Daisy chain from CTS)
- 5) Unused
- 6) Digital GND
- 7) RXD (from TXD of control source)
- 8) TXD (to RXD of control source)

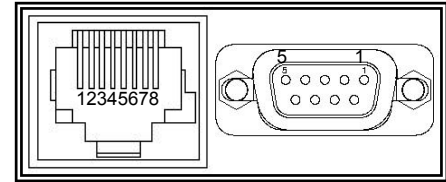

**Control Inputs**

\*DTR/DSR also applies to Canon VCC-50i Products featuring Vaddio's exclusive VISCA Control Translation

DB-9 Pins

- 2) Through to Pin 8 (TXD)
- 3) Through to Pin 7 (RXD)
- 5) Through to Pin 6 of RJ-45

**Control Output to Camera**

**Control Output Connection RJ-45**

RJ-45 Pins

- 1) DSR (Sony\* Daisy chain from DTR)
- 2) DTR (Sony\* Daisy chain to DSR)
- 3) RTS (Canon Daisy chain from CTS)
- 4) CTS (Canon Daisy chain to RTS)
- 5) Unused
- 6) Digital GND
- 7) TXD (to RXD of control source)
- 8) RXD (from TXD of control source)

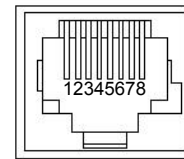

**Control Out to Camera**

\*DTR/DSR also applies to Canon VCC-50i Products featuring Vaddio's exclusive VISCA Control Translation

**CARE AND CLEANING**

Do not attempt to take the Quick-Connect 4 apart. There are no user-serviceable components inside. Disassembly of the device will void the warranty.

- Do not spill liquids onto the device
- Keep this device away from food and liquid
- For smears or smudges, clear any dust with a blower and wipe stains with a clean, soft cloth. Do not use any abrasive chemicals.

**OPERATING AND STORAGE CONDITIONS**

Do not store or operate the Quick-Connect 4 under the following conditions for any circumstance:

- Temperatures above 40°C (104°F)
- Temperatures below 0°C (32°F)
- High humidity, condensing or wet environments
- Dusty environments
- In inclement weather
- Under severe vibration

**GENERAL  
SPECIFICATIONS**

<b>Camera Ports:</b>	4-Individual RS-232
<b>Control Through Ports:</b>	2-inputs on RJ-45F and DB9F per camera 1-output on RJ-45F per camera
<b>Power Supply:</b>	18 VDC, 5.5 Amp, 100W
<b>Video Output Connections:</b>	S-Video out on 4-pin mini din & Composite Video Out on BNC (Both signals are live)
<b>Size:</b>	2-Space Rack Mount Height - 3.5" (8.89cm) 4" (10.16cm) Deep
<b>Weight:</b>	2.2 lbs, 1kg

**WARRANTY  
INFORMATION**

**Hardware\* Warranty** - One year limited warranty on all parts. Vaddio warrants this product against defects in materials and workmanship for a period of one year from the day of purchase if Vaddio receives notice of such defects during the warranty. They will, at its option, repair or replace products that prove to be defective.

**Exclusions** - The above warranty shall not apply to defects resulting from: improper or inadequate maintenance by the customer, customers applied software or interfacing, unauthorized modifications or misuse, operation outside the normal environmental specifications for the product, use of the incorrect power supply, or improper site operation and maintenance.

**Vaddio Customer Service** – Vaddio will test, repair, or replace the product or products without charge if the unit is under warranty. If the product is out of warranty, Vaddio will test then repair the product or products. The cost of parts and labor charge will be estimated by a technician and confirmed by the customer prior to repair. All components must be returned for testing as a complete unit. Vaddio will not accept responsibility for shipment after it has left the premises.

**Return Material Authorization (RMA) number** - Before returning a product for repair or replacement request an RMA from Vaddio's technical support. Provide a technician with a return phone number, e-mail address, shipping address, and product serial numbers. Describe the reason for repairs or returns as well as the date of purchase. Include your assigned RMA number in all correspondence with Vaddio. Write your assigned RMA number on the outside of the box when returning the product.

**Voided warranty** – The warranty does not apply if the original serial number has been removed or if the product has been disassembled or damaged through misuse, accident, modifications, or unauthorized repair.

**Shipping and handling** - Vaddio will not pay for inbound shipping transportation or insurance charges or accept any responsibility for laws and ordinances from inbound transit. Vaddio will pay for outbound shipping, transportation, and insurance charges all items under warranty but will not assume responsibility for loss and/or damage by the outbound freight carrier. If the return shipment appears damaged, retain the original boxes and packing material for inspection by the carrier. Contact your carrier immediately.

**Products not under warranty** - Payment arrangements are required before outbound shipment for all out of warranty products.

*\*Vaddio manufactures its hardware products from parts and components that are new or equivalent to new in accordance with industry standard practices.*

